

Aesculap[®] S4[®] Cervical Navigation

Navigated Instruments for Posterior Cervical Stabilization
Surgical Technique



Aesculap Spine

S4[®] Cervical Navigation

Content

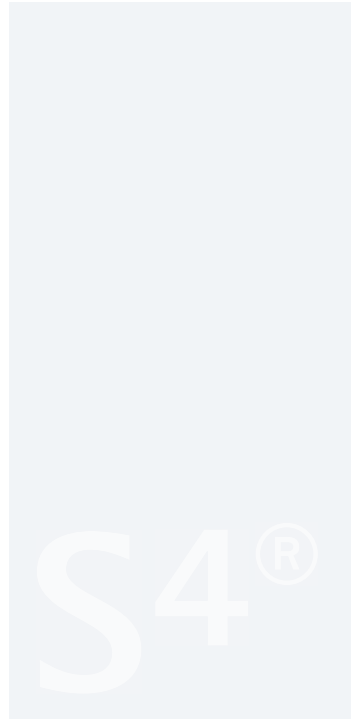

A System Overview

B Surgical Technique

Pre-Operative Planning

Patient Positioning

Patient Registration

Validation and Verification of the Pre-Calibrated Instruments

Navigated Polyaxial Screw Fixation C1-Th3

Navigated C1 Screw Fixation

Navigated Operation C1-C2 – Opening the Cortex

C Instrumentation Possibilities – Summary

D Instrument Overview and Set

Overview

A

The special needs of the cervical spine make posterior cervical stabilization a challenging procedure. Due to the sensitivity of the neurovascular structures surrounding the delicate and complex cervical spine, accuracy has always been a key factor.¹

Increasing accuracy and safety in screw placement can be achieved through a navigation system,^{2,3} ideally combined with integrated instruments.

Spinal navigation has substantially advanced during the past ten years⁴: Planning the skin incision, localization of the screw entry points and of course length and trajectory of the screws can be determined based on navigation technology.

Literature reports the following advantages:

- Higher accuracy and safety in screw placement^{1,2}
- Reduction of X-ray exposure for the patient and the OR Team⁵
- Support for complex cases⁶

For a smooth and seamless workflow, the S⁴® Cervical instruments are fully integrated in the Brainlab navigation system.



Aesculap S⁴® Cervical



Brainlab Navigation System

¹ Abumi K, Ito M, Sudo H. Reconstruction of the subaxial cervical spine using pedicle screw instrumentation. *Spine (Phila Pa 1976)*. 2012 Mar 1;37(5):E349-56.

² Kotani Y, Abumi K, Ito M, Minami A. Improved accuracy of computer-assisted cervical pedicle screw insertion. *J Neurosurg*. 2003 Oct;99(3 Suppl):257-63.

³ Barsa P, Fröhlich R, Beneš V 3rd, Suchomel P. Intraoperative portable CT-scanner based spinal navigation a feasibility and safety study. *Acta Neurochir (Wien)*. 2014 Sep;156(9):1807-12.

⁴ Suchomel P, Hradil J, Fröhlich R, Barsa P, Lukás R. Navigation techniques in surgery of crania-cervical junction and upper cervical spine. *Acta Chir Orthop Traumatol Cech*. 2009 Apr;76(2):137-48. Czech.

⁵ Kim CW, Lee YP, Taylor W, Oygar A, Kim WK. Use of navigation-assisted fluoroscopy to decrease radiation exposure during minimally invasive spine surgery. *Spine J*. 2008 Jul-Aug;8(4):584-90. doi: 10.1016/j.spinee.2006.12.012. Epub 2007 Feb 20.

⁶ Guppy KH, Chakrabarti I, Banerjee A. The use of intraoperative navigation for complex upper cervical spine surgery. *Neurosurg Focus*. 2014 Mar;36(3):E5.

S4[®] Cervical Navigation

Overview

This surgical technique guide describes the use of Aesculap's navigated S4[®] Cervical Instruments. The variety of the S4[®] Cervical implants as well as the non-navigated instruments are described in the surgical technique guide 095302 and 034202.

Additional information can be found in the instruction for use S4[®] Cervical Navigated Instruments TA013660, S4[®] Cervical Implants TA011796 and S4[®] Cervical Instruments TA011984.

S4[®] Cervical offers not only basic instruments for simple insertion but also additional support instrument systems for ease of use in challenging situations, especially in C1 and C2. Also these support instruments can be navigated as the summary in chapter C on page 30-33 illustrates.



095302
S4[®] Cervical System Refresh



034202
S4[®] Cervical System





This instrument has been equipped with the Brainlab navigation interface, which means that the instrument is prepared to be used together with Brainlab image guided surgery systems.

For more information on safe handling of Brainlab instruments as well as on the Spine & Trauma 3D Software, refer to the relevant instrument and software user guides.

Website Brainlab

<https://www.brainlab.com> → Contact Us → Customers

S4[®] Cervical Navigation

Surgical Technique

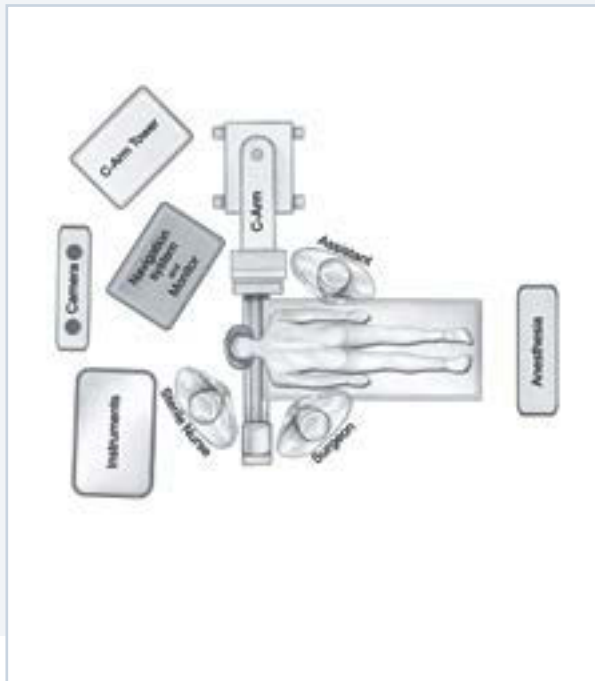

Fig. 1: Proposed Patient Positioning C1-C2

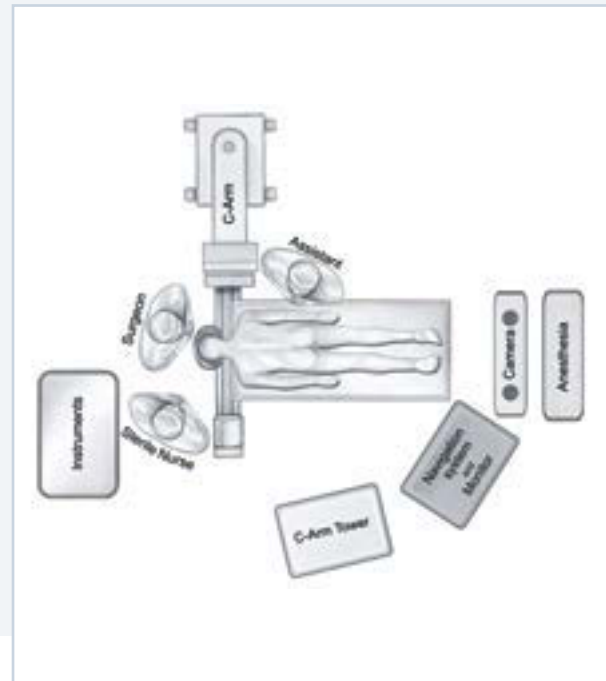

Fig. 2: Proposed Patient Positioning Subaxial

Pre-Operative Planning

CT Data supports for the identification of the patient specific anatomy and shows the precise insertion points, trajectory and indicates the screw lengths.

Patient Positioning

The patient is placed in a prone position with the head supported in a holder (e.g. Mayfield clamp). Whenever it is safe to do so, position the spine in physiological alignment.

A correct positioning is very important and special care should be taken when fixing the occiput to the cervical and upper thoracic spine. The correct alignment should be controlled with X-ray prior to draping the patient.

The navigation system should be positioned and directed in a way that the camera has free visual access to the OR situs, to make sure navigation is continuously possible (Fig. 1 and 2).



Fig. 3a: Patient Registration



Fig. 3b: Patient Registration

Patient Registration

The image guided registration process is possible either based on 2D fluoroscopic images, fluoro 3D or CT data sets.

If CT data is used, the Brainlab pointer is used intraoperatively to perform surface matching. Several points on the bony surface are identified and every pivot point is shown on the screen of the navigation system (Fig. 3a, 3b).

S4[®] Cervical Navigation

Surgical Technique



Fig. 4: Brainlab Tool Box Instrument Selection

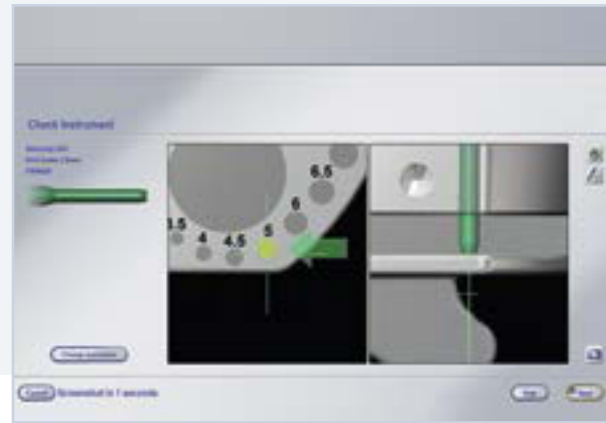

Fig. 5: Verification of Instrument Accuracy

Validation and Verification of the Pre-Calibrated Instruments

- Prior to each use, please check and/or validate the navigated instruments with the Brainlab instrument calibration matrix Rev. 4 ("Calibration with ICM4", Fig. 6).
- Select instruments from the tool box of the navigation system (Fig. 4).
- Use instrument calibration matrix Rev. 4 ("Calibration with ICM4") to match the specification of the integrated instrument to the navigation system (Fig. 5).
- For validation or verification of the S4[®] Cervical instruments, consider the following:
 - FW664R & FW665R Navigated drill guides must be equipped with Aesculap star unit FW652R
 - FW660R Navigated guide sleeve for 3.5 mm / 4.0 mm screws must be equipped with FW652R and inner drill sleeve FJ985R / FW661R
 - FW658R Navigated guide sleeve for Smooth-Shank Screws must be equipped with FW652R, validated/verified using reducing sleeve FW657R
 - FW655R Navigated tap validated/verified with Brainlab star unit 55830-20A "pre-calibrated"

Notes:

- Please make sure that the drill or cortical punch are removed prior to validation or verification.
- Further information regarding calibration and verification of instruments with the S4[®] Cervical instruments and the Brainlab system can be found in the Brainlab user guide.



Fig. 6: Instrument Calibration Matrix ICM4



Fig. 7: Reduction Sleeve

- Use the reduction sleeve (Fig. 7) to calibrate the navigated guide sleeve for Smooth-Shank Screw through the 30 mm hole of calibration matrix Rev. 4 ("Calibration with ICM4") (Fig. 6).
- After successful calibration of the sleeve guide drilling, tapping and screw insertion can be performed through the navigated guide.

The accuracy of the navigation should be controlled and confirmed with X-ray and/or 3D-Scans.

Note:

For further information regarding calibration and verification of S4® Cervical instruments and the Brainlab system, refer to the Brainlab user guides.

S4[®] Cervical Navigation

Surgical Technique

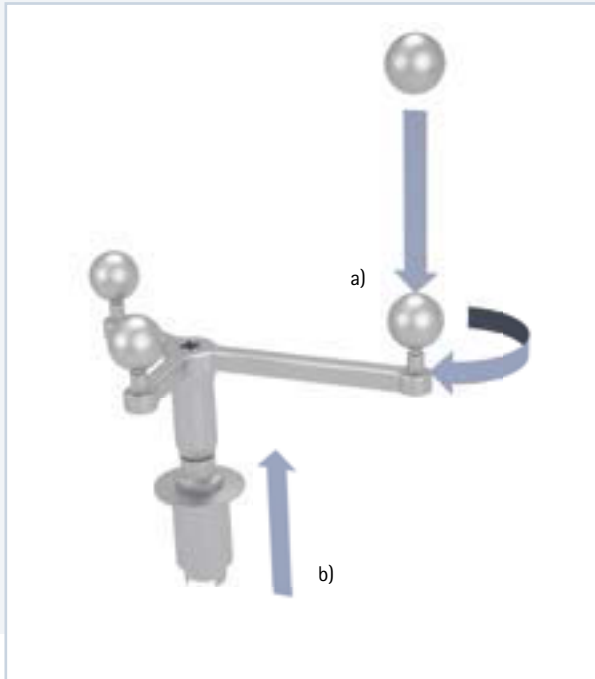

Fig. 8: Preparation Aesculap Star Unit

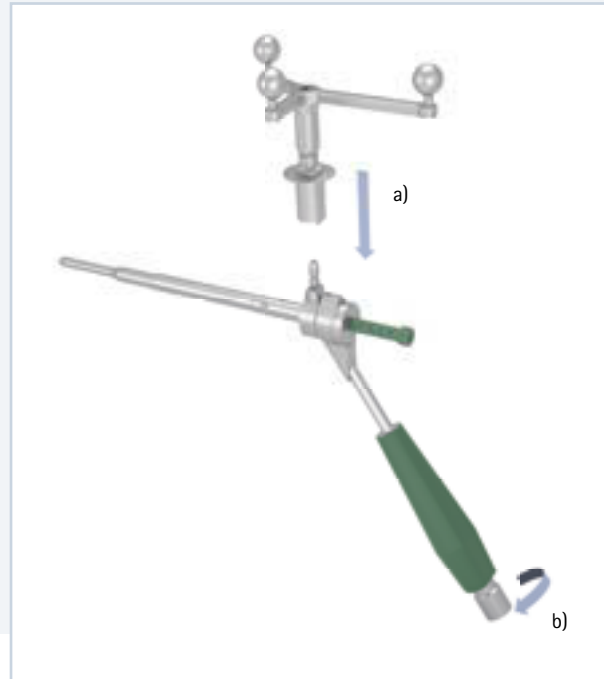

Fig. 9: Preparation of Navigated Drill Guide

Navigated Polyaxial Screw Fixation C1–Th3

Preparation of the Navigated Drill Guide

- Mount the reflective marker spheres on the Aesculap star unit (FW652R, Fig. 8a). For more information for safe mounting of the IGS Star Unit please refer to the Brainlab user guides.
- Retract and hold locking sleeve of the Aesculap star unit against the spring pressure in the direction of the arrow (Fig. 8b).
- The Aesculap star unit is then pushed onto adapter of the drill guide FW664R/FW665R. When doing so, ensure that the pin of the adapter engages in the recess on the star unit. Then release locking sleeve (Fig. 9a).
- To ensure that the camera has an unrestricted view of the reflective marker spheres, loosen knob on the handle of the drill guide and rotate the Aesculap star unit to the desired position. Once the desired position is reached, please tighten the knob again (Fig. 9b).
- The guide sleeve and the corresponding instruments for the Ø 4.0 mm screws are marked with a purple ring for a quick identification.

For Ø 3.5 mm screws:

- Navigated drill guide for Ø 3.5 mm screws (FW664R)

For Ø 4.0 mm screws:

- Navigated drill guide for Ø 4.0 mm screws (FW665R)

Note:

The possibility to rotate the Aesculap star unit is also very useful for adjusting the handle for an enhanced ergonomic working situation through all operative steps.

Alternatively for Ø 3.5 mm or 4.0 mm screws the navigated guide sleeve FW660R can be used (see page 24–29).



Fig. 10: Opening the Cortex

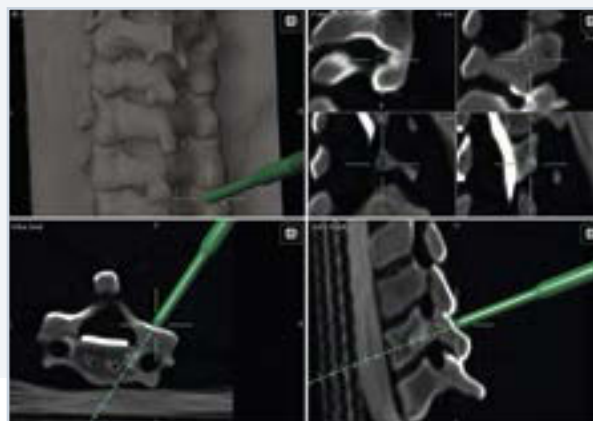

Opening the Cortex with Navigation

- Adjust the desired depth by turning the depth stop of the navigated drill guide (FW664R/FW665R). Each half run moves a distance of 0.5 mm. Introduce the cortical punch (FW688R/FW689R) into the drill guide. To prevent soft tissue injury make sure that the tip of the cortical punch is not coming out of the drill guide when approaching the bone.
- Position the punch together with the drill guide on the desired entry point and advance the punch into the bone until the stop is met.

For Ø 3.5 mm screws:

- Cortical punch Ø 3.5 mm (FW688R)
- Navigated drill guide for Ø 3.5 mm screws (FW664R)

For Ø 4.0 mm screws:

- Cortical punch Ø 4.0 mm (FW689R)
- Navigated drill guide for Ø 4.0 mm screws (FW665R)

Note:

Activate the virtual offset on the navigation system for real time navigation of the instrument. Extend the instrument with a virtual line to help define the correct trajectory.

S4[®] Cervical Navigation

Surgical Technique



Fig. 11a: Navigated Drill Guide for Ø 3.5 mm Screws



Fig. 11b: Navigated Drill Guide for Ø 4.0 mm Screws

Navigated Drilling

- Navigated drilling is performed through the corresponding drill guides.

For Ø 3.5 mm screws:

- Ø 2.4 mm drill (FW666SU)
- Navigated drill guide for Ø 3.5 mm screws (FW664R)

For Ø 4.0 mm screws:

- Ø 2.9 mm drill (FW667SU)
- Navigated drill guide for Ø 4.0 mm screws (FW665R)

- The guide sleeve and the corresponding instruments for the Ø 4.0 mm screws are marked with a purple ring for a quick identification.



Fig. 12: Navigated Drilling

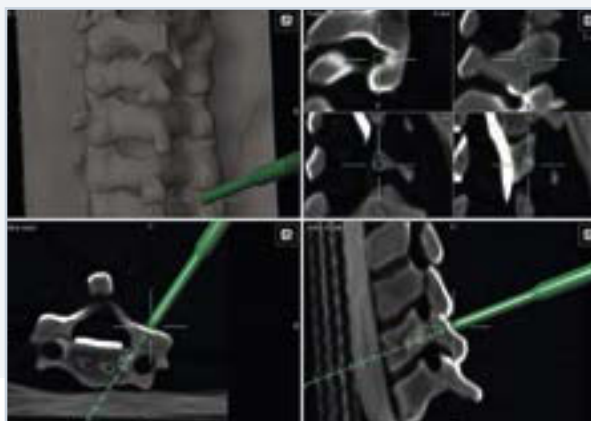

Navigated Drilling

- Adjust the desired depth by turning the depth stop of the navigated drill guide. Each half run moves a distance of 0.5 mm. Introduce the drill bit into the drill guide.
- Before drilling, the pre-set drill length must be checked with a caliper (e.g. AA845R, CASPAR® instrument for anterior cervical fusion).
- Position the instruments together at the intended screw entry point.
- Then drill carefully to the predefined depth under control with the Brainlab navigation system.

S4[®] Cervical Navigation

Surgical Technique



Fig. 13: Preparation Brainlab Star Unit (pre-calibrated)

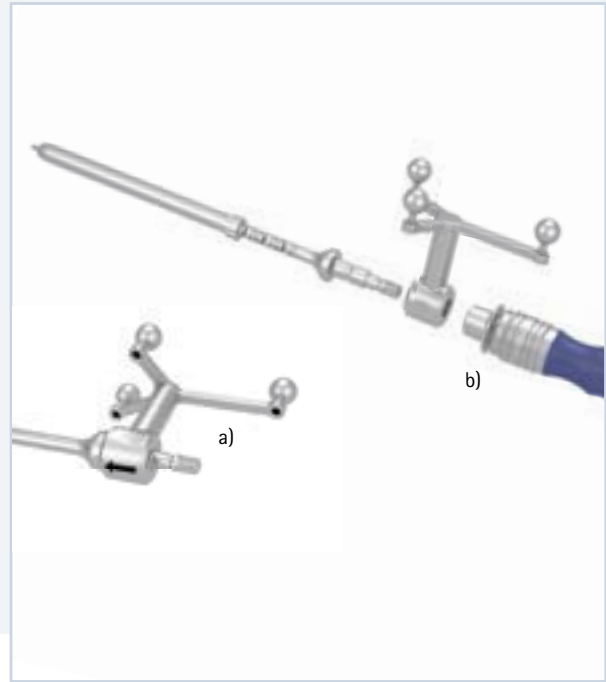

Fig. 14: Preparation of Navigated Tap

Preparation for Navigated Tapping

- Mount the reflective Brainlab marker spheres onto the IGS Tool Star Unit 55830-20A (pre-calibrated, Fig. 13). For more information for safe mounting of the IGS Star Unit please refer to the Brainlab user guides.
- Push the IGS Tool Star Unit onto the shaft of the tap (FW655R). Ensure that the star unit is securely fitted onto the shaft tap. Please make sure that the arrow on the ring of the Brainlab star unit shows in the direction of the distal working end (Fig. 14a).
- Push the handle (FW067R or FW165R) onto the shaft of the tap. To prevent interference of hand with star unit we recommend using the ratchet handle FW165R. Retract and hold locking sleeve against the spring pressure. Push the handle onto the shaft of the tap, then release the locking sleeve and check that the handle is engaged (Fig. 14b).

Note:

The star unit can be rotated on the shaft of the tap. During tapping one hand turns on the handle while the other hand holds the Instrument Star Unit to enable continuous visual access of the camera to the Instrument Star Unit.



Fig. 15: Navigated Tapping

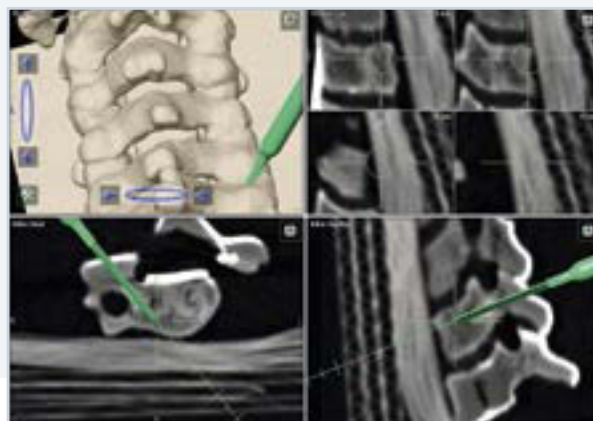

Navigated Tapping

- All S4® Cervical screws are self-tapping. However, it is recommended to tap the the first 2-3 mm through the cortical shell which will enable easier screw starting afterwards.
- A scale on the shaft of the tap indicates the depth while tapping.

For Ø 3.5 mm screws:

- Tap for Ø 3.5 mm screws (FW655R)

For Ø 4.0 mm screws: see page 28

- Tap for Ø 4.0 mm screws (FW089R)
- Navigated guide sleeve for Ø 3.5 mm / 4.0 mm screws (FW660R, black / gold marked)

Note:

The navigated tap FW655R does not need to be inserted through the drill guide as it is equipped with a self-retracting sleeve.

S4[®] Cervical Navigation

Surgical Technique



Fig. 16: Preparation Brainlab Star Unit ("Calibration with ICM4")

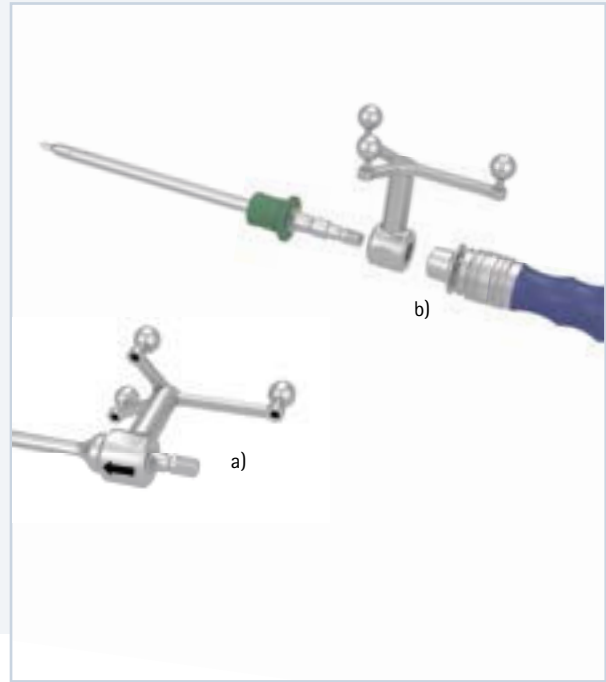

Fig. 17: Preparation of Navigated Screwdriver

Preparation for Navigated Screw Placement

- Mount the reflective Brainlab marker spheres onto the IGS Tool Star Unit 55830-25A (Calibration with ICM4, Fig. 16). For more information for safe mounting of the IGS Star Unit please refer to the Brainlab user guides.
- Push the IGS Tool Star Unit onto the shaft of the screwdriver (FW656R). Ensure that the star unit is securely fitted onto the shaft. Please make sure that the arrow on the ring of the Brainlab star unit shows in the direction of the distal working end (Fig. 17a).
- Push the handle (FW067R or FW165R) onto the shaft of the screwdriver. To prevent interference of hand with star unit we recommend using the ratchet handle FW165R. Retract and hold locking sleeve against the spring pressure. Push the handle onto the shaft of the screwdriver, then release the locking sleeve and check that the handle is engaged (Fig. 17b).
- After successful manual calibration using the instrument calibration matrix Rev. 4 ("Calibration with ICM4") the screws can be inserted.

Note:

The star unit can be rotated on the shaft of the screwdriver. During screw insertion one hand turns on the handle while the other hand holds the star unit to enable continuous visual access of the camera to the Instrument Star Unit.

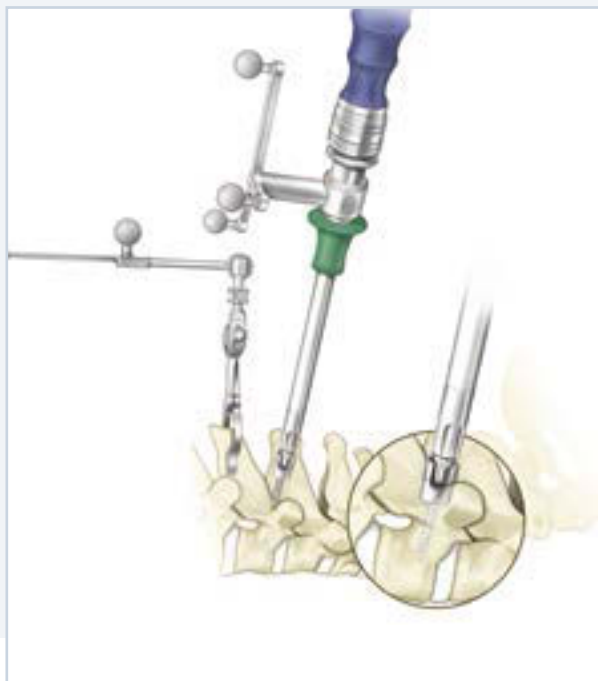
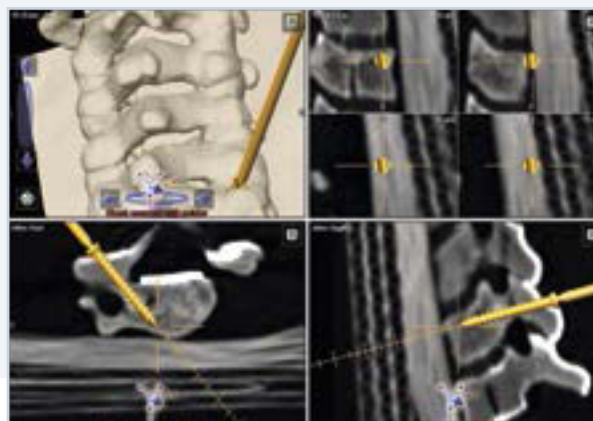

Fig. 18: Navigated Screw Placement



Navigated Screw Placement

- The 3.5 mm and 4.0 mm screws are inserted into the prepared holes using the navigated screwdriver (FW656R).
- The screwdriver is fitted with a self-retaining function to prevent the screw from falling out when it is passed to the surgeon.
- To attach the screw onto the screwdriver, pull the green trigger towards the handle, insert the screw on the end of the screwdriver while the trigger is retracted, then release the green trigger.
- The screw is now held by the screwdriver until the screw is completely inserted into the bone.
- To disengage the screwdriver from the screw, pull back on the green trigger and maintain this while extracting the driver from the screw.

Note:

The hex end of the self-retaining screwdriver must be fully inserted into the inner hex of the screw.

S4[®] Cervical Navigation

Surgical Technique



Fig. 19: Navigated Operation on C1

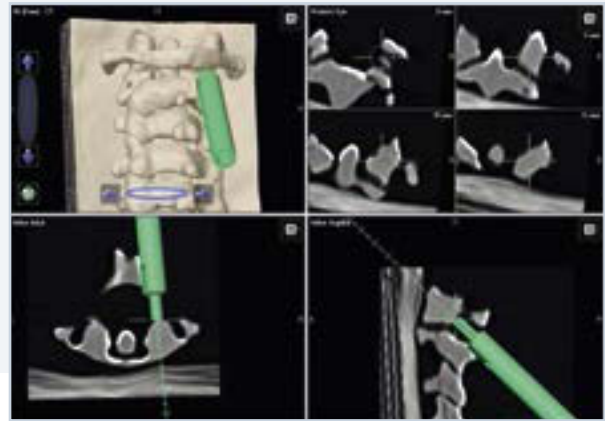

Navigated C1 Screw Fixation

Navigated Operation on C1

Since the anatomy at C1 is very challenging Aesculap has developed special instruments and implants to meet those special anatomical challenges. The occipital nerve as well as the vertebral artery lie very close to the entry point of the polyaxial Smooth-Shank Screw. To protect those structures, a special navigated guiding sleeve with a window was designed. Through this sleeve, the opening of the cortical bone, the drilling, tapping and screw insertion can be performed.

The guide sleeve and the corresponding instruments for Smooth-Shank Screws are marked with a light-blue ring for a quick identification.

Note:

Due to the difficulties of placing the clamp on C1, please note that there might be disruptions when placing the clamp on C2 or the head holder clamp (Mayfield).

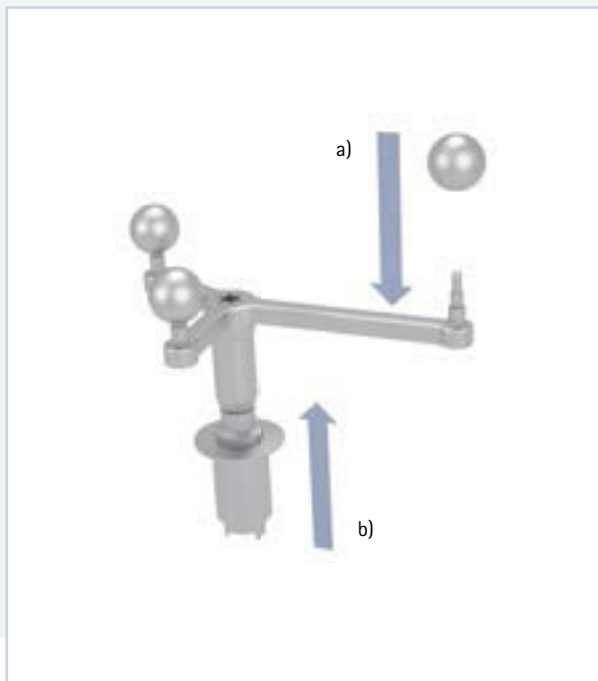

Fig. 20: Preparation Aesculap Star Unit

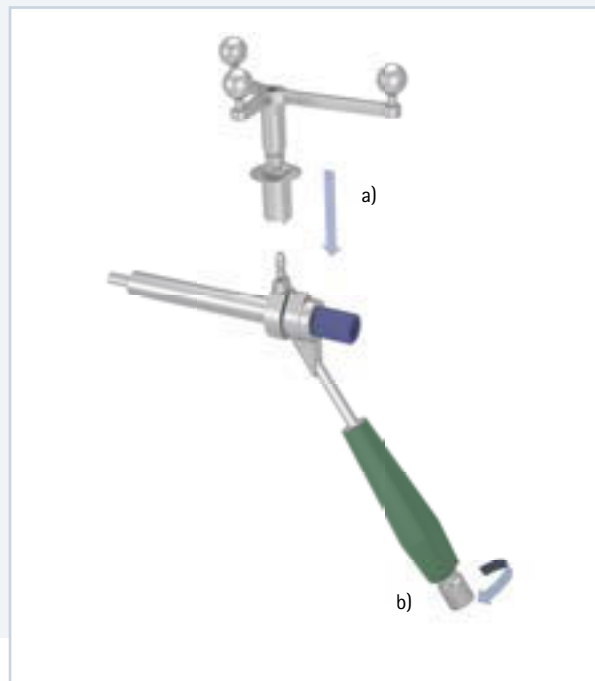

Fig. 21: Preparation of Guide Sleeve for Smooth-Shank Screws

Preparation of the Navigated Guide Sleeve for Smooth-Shank Screws

- Mount the reflective marker spheres on the Aesculap star unit (FW652R, Fig. 20a). For more information please refer to the Brainlab user guides.
- Retract and hold locking sleeve of the Aesculap star unit against the spring pressure in the direction of the arrow (Fig. 20b).
- The Aesculap star unit is then pushed onto adapter of the guide sleeve for Smooth-Shank Screws (FW658R). When doing so, ensure that the pin of the adapter engages in the recess on the star unit. Then release locking sleeve (Fig. 21a).
- To ensure that the camera has an unrestricted view of the reflective marker spheres, loosen knob on the handle of the navigated guide sleeve and rotate the Aesculap star unit to the desired position. Once the desired position is reached, please tighten the knob again (Fig. 21b).

Note:

The possibility to rotate the Aesculap star unit is also very useful for adjusting the handle for an enhanced ergonomic working situation through all operative steps.

S4[®] Cervical Navigation

Surgical Technique

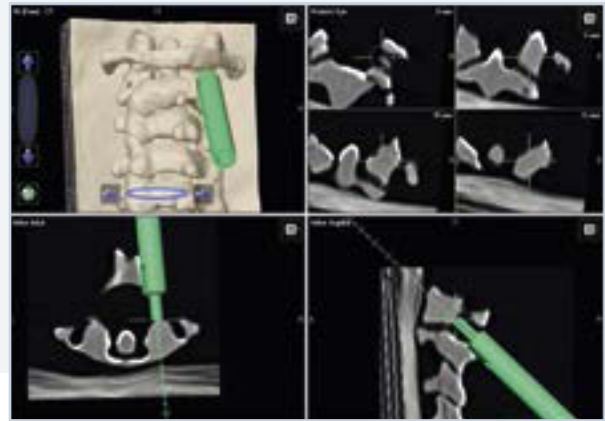
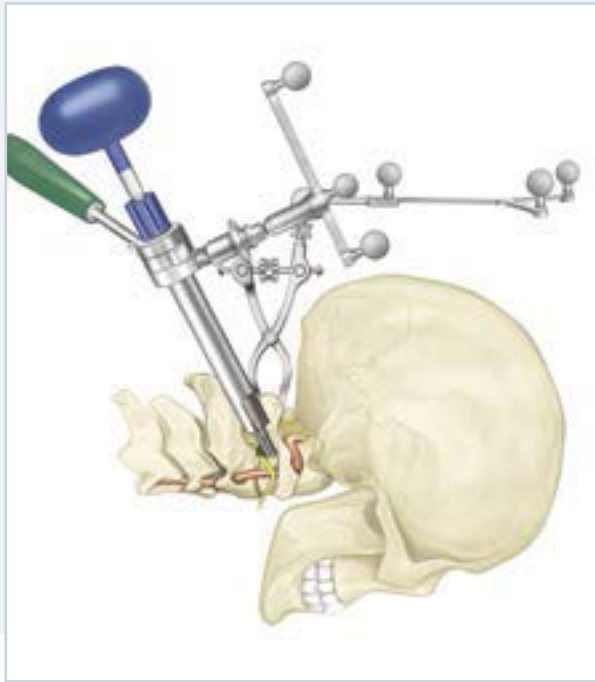

Fig. 22: Opening the Cortex

Navigated Operation on C1 – Opening the Cortex

- The cortical bone can be opened by using the Smooth-Shank Screw cortical punch (FW085R) through the navigated guide sleeve (FW658R). The cortical punch has a safety stop to prevent too deep insertion.

Attention:

Ensure that the window of the guide sleeve is closed during the preparation and insertion of the screw with the guide sleeve. (See laser marking on the inner sleeve (OPEN / CLOSE)).

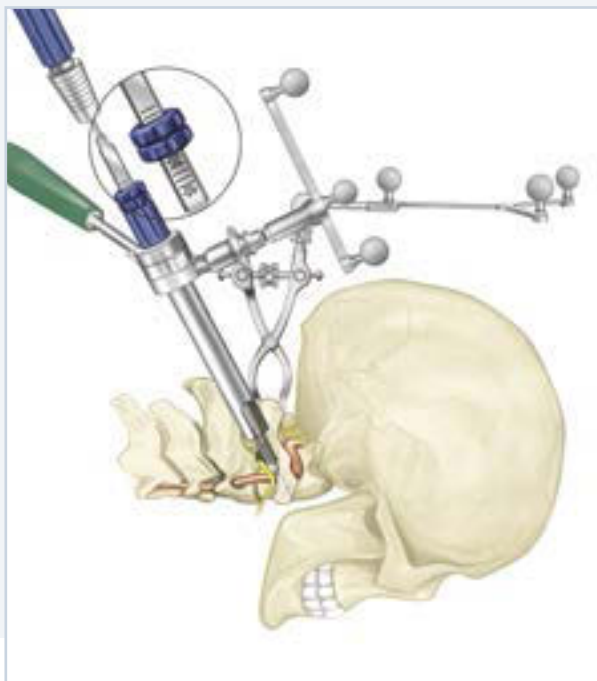

Fig. 23: Drilling

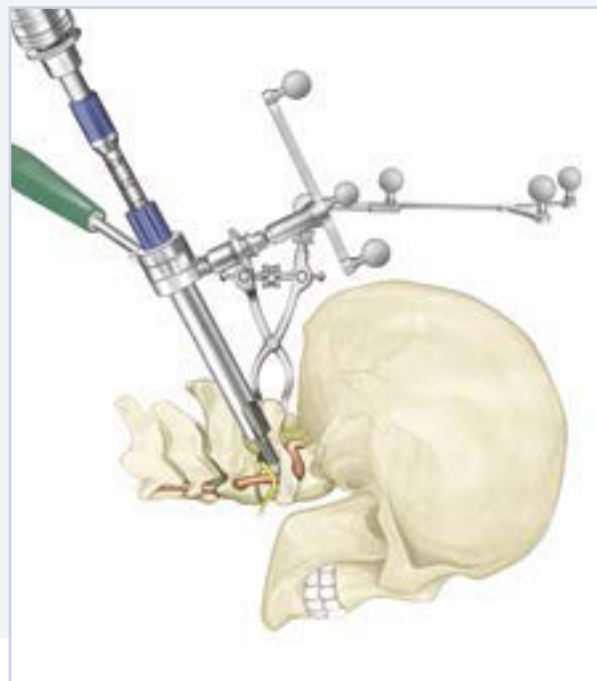

Fig. 24: Tapping

Navigated Operation on C1 – Drilling & Tapping

- The drill for Smooth-Shank Screws (FW086SU) has a scale and two wheels to adjust the drill depth. Before drilling, the pre-set drill length must be checked with a caliper (e.g. AA845R, CASPAR® instrument for anterior cervical fusion). Insert the drill into the navigated guide sleeve (FW658R) and drill carefully to the predefined depth under control with the Brainlab navigation system.
- To ensure optimal bone purchase tapping is recommended for the first 3 mm in unicortical screw placement or through the second cortex in bicortical screw placement.
- To prepare the drill holes for the screws insert the Smooth-Shank Screw tap (FW087R) into the navigated guide sleeve (FW658R) and slowly and steadily tap in until the desired depth is reached. When doing so, read the thread depth on the tap scale.

Attention:

Ensure that the window of the guide sleeve is closed during the preparation and insertion of the screw with the guide sleeve. (See laser marking on the inner sleeve (OPEN/CLOSE)).

S4[®] Cervical Navigation

Surgical Technique

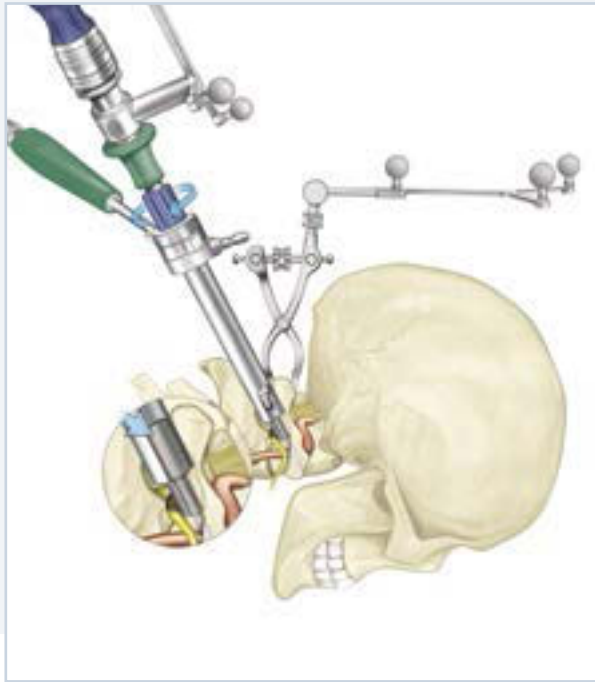
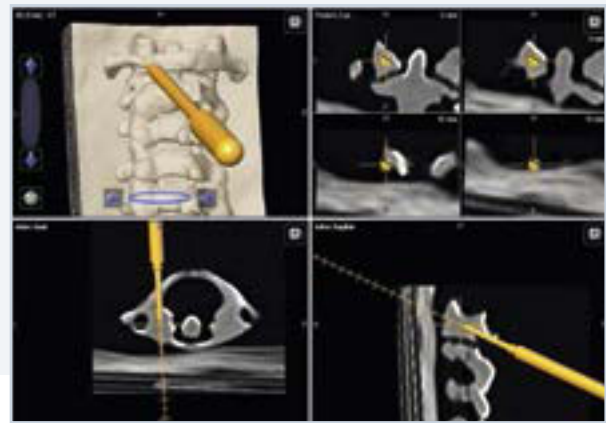

Fig. 25: Navigated Screwdriver with Regular Guide Sleeve for Smooth-Shank Screws



Navigated Operation on C1 – Smooth-Shank Screw Insertion

- With the navigated guide sleeve (FW658R) still attached, the Smooth-Shank Screw can be inserted. Remove the Aesculap star unit on the navigated guide sleeve and only use navigated screwdrivers to insert the screw (e.g. FW656R).
- The window can be opened after the screw is started to ensure a perfect sight onto the screw.
- When the desired depth is reached and all thread is inside the bone and only the smooth shank is sticking out, the navigated guide sleeve can be removed laterally from the screw.

Attention:

For screw insertion remove the Aesculap star unit from the C1 guide sleeve FW658R. Then use a navigated S4[®]C screwdriver (e.g. FW656R) through the non-navigated C1 guide sleeve for screw insertion.

Attention:

Ensure that the window of the guide sleeve is closed during the preparation and insertion of the screw with the guide sleeve. (See laser marking on the inner sleeve (OPEN/CLOSE)).

B

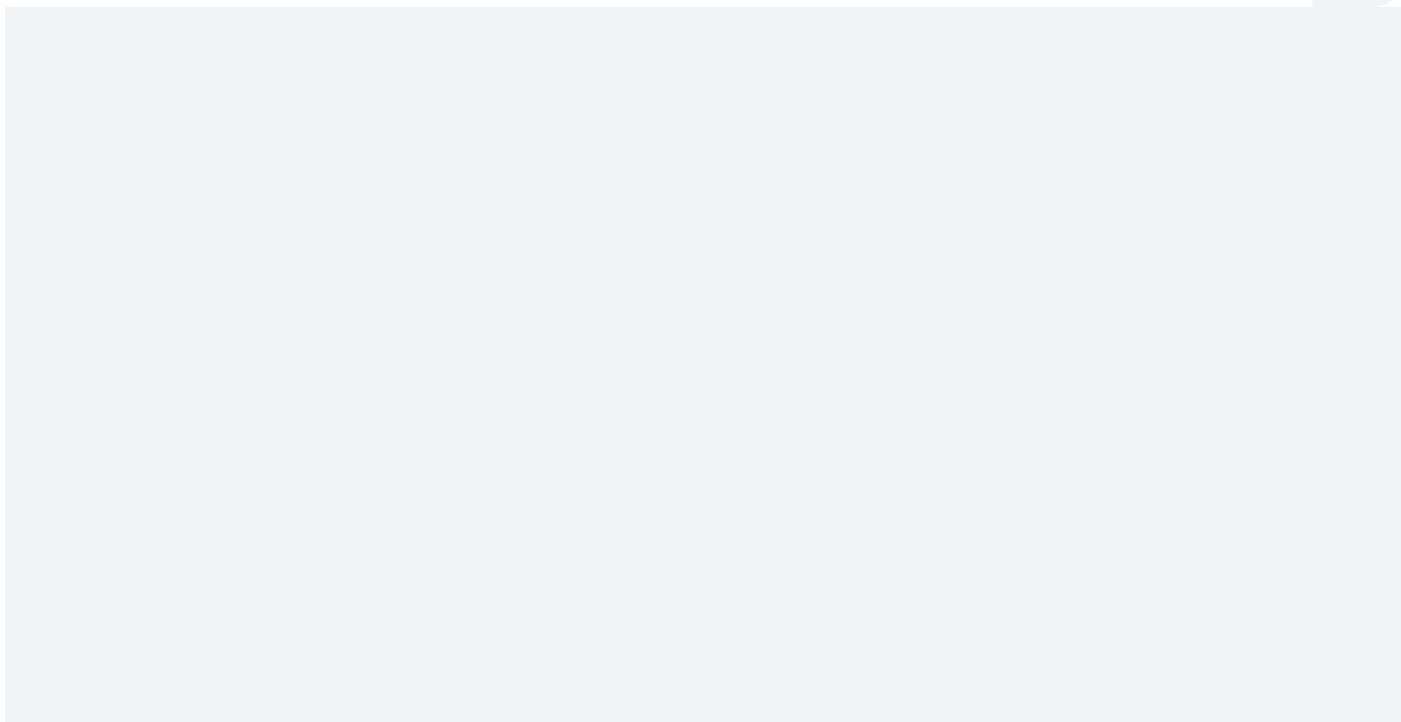

S4[®] Cervical Navigation

Surgical Technique

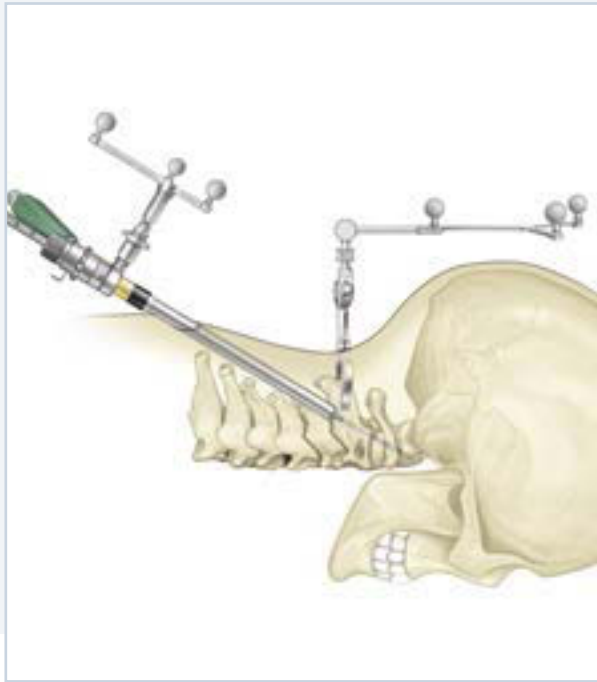
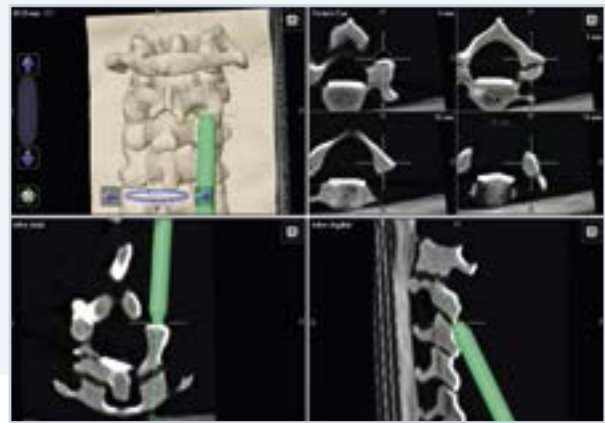

Fig. 26: Navigated Operation on C1-C2 Transarticular Screw Fixation



Navigated C1-C2 Transarticular Screw Fixation

The favored angle instrument components are based on the classical Magerl technique¹ for transarticular screw fixation. However, this instrumentation has been designed to reduce the approach to a minimum, keeping approach related surgical trauma as insignificant as possible. This technique involves standard exposure of the C1-C2 area posteriorly and placement of screws bilaterally down the isthmus of C2 and across the C1-C2 articulation to block movement and provide immediate internal fixation. The navigated guide sleeve system, which is partly placed subcutaneously, not only makes the positioning of the implant more accurate and easier, but also protects the tissue while the instruments are guided safely into use.

The guide sleeve and the corresponding instruments for transarticular screw placement are marked black for 3.5 mm screws and gold for 4.0 mm screws.

Note:

Due to the difficulties of placing the clamp on C1, please note that there might be disruptions when placing the clamp on C2 or the head holder clamp (Mayfield).

¹ As originally described in: Magerl F, Seemann PS. Stable posterior fusion of the atlas and axis by transarticular screw fixation. In: Kehr P, Weidner A, eds. *Cervical Spine*. Wien, etc: Springer-Verlag. 1987:322-7.

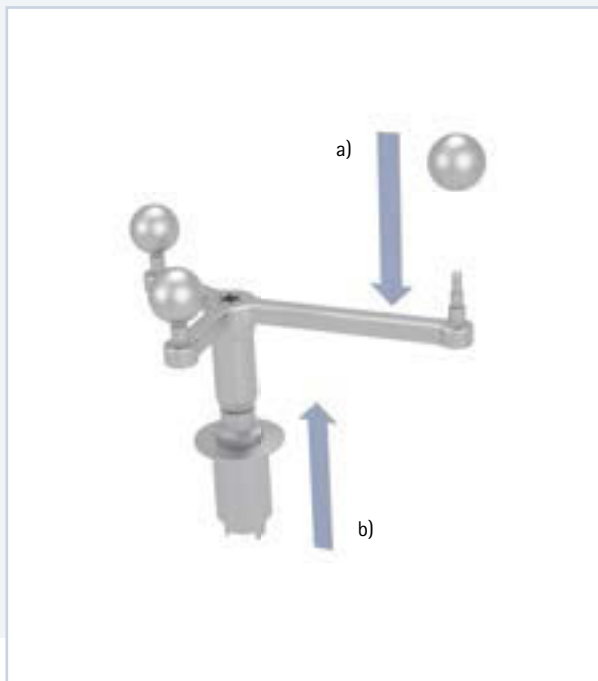

Fig. 27: Preparation Aesculap Star Unit

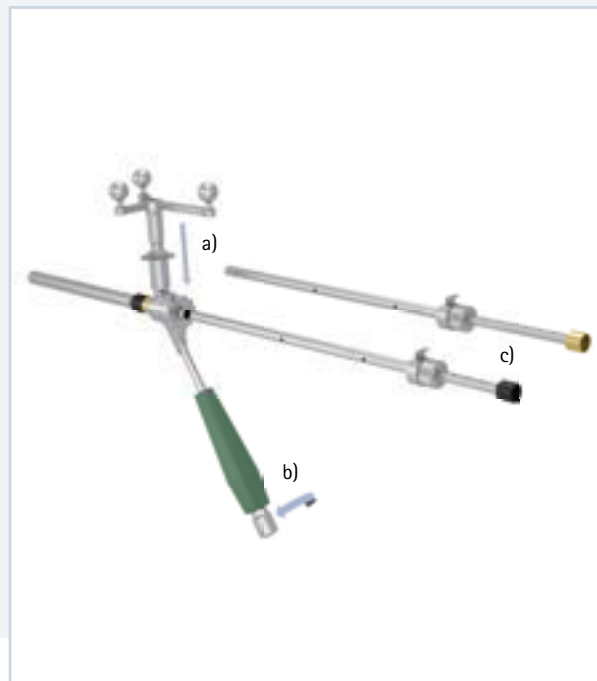

Fig. 28: Preparation of Guide Sleeve for C1-C2 Transarticular Screw Fixation

Preparation of the Navigated Guide Sleeve for C1-C2

- Mount the reflective marker spheres on the Aesculap star unit (FW652R, Fig. 27a). For more information see Brainlab user guides.
- Retract and hold locking sleeve of the Aesculap star unit against the spring pressure the direction of the arrow (Fig. 27b).
- The Aesculap star unit is then pushed onto adapter of the guide sleeve FW660R. When doing so, ensure that the pin of the adapter engages in the recess on the star unit. Then release locking sleeve (Fig. 28a).
- To ensure that the camera has an unrestricted view of the reflective marker spheres, loosen knob on the handle of the navigated guide sleeve and rotate the Aesculap star unit to the desired position. Once the desired position is reached, please tighten knob again (Fig. 28b).
- Insert either the the inner drill sleeve for \varnothing 3.5 mm screws (FW661R) or the corresponding sleeve for \varnothing 4.0 mm screws (FJ985R) for validation or verification (Fig. 28c).

Note:

The possibility to rotate the Aesculap star unit is also very useful for adjusting the handle for an enhanced ergonomic working situation through all operative steps.

S4[®] Cervical Navigation

Surgical Technique



Fig. 29: Opening the Cortex

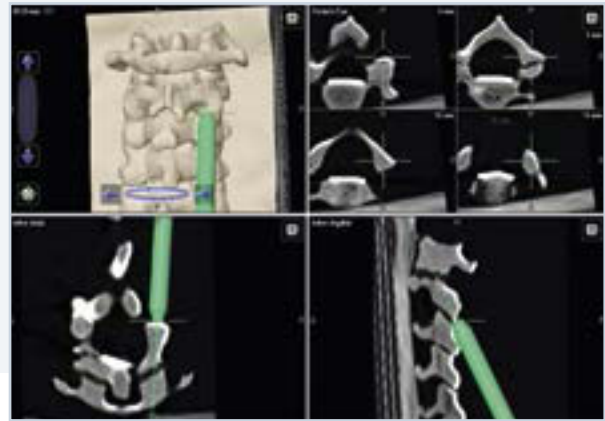

Navigated Operation C1-C2 – Opening the Cortex

- Remove the inner drill sleeve (FJ985R / FW661R) from the navigated guide sleeve (FW660).
- Insert the obturator (FJ983R) into the inner sleeve of the navigated guide sleeve (FW660) and bring both into the operating field through the stab incision and position it in place.
- After removing the conical obturator, a sharp trocar (FJ984R) is available to make a starter hole in the bone if desired.

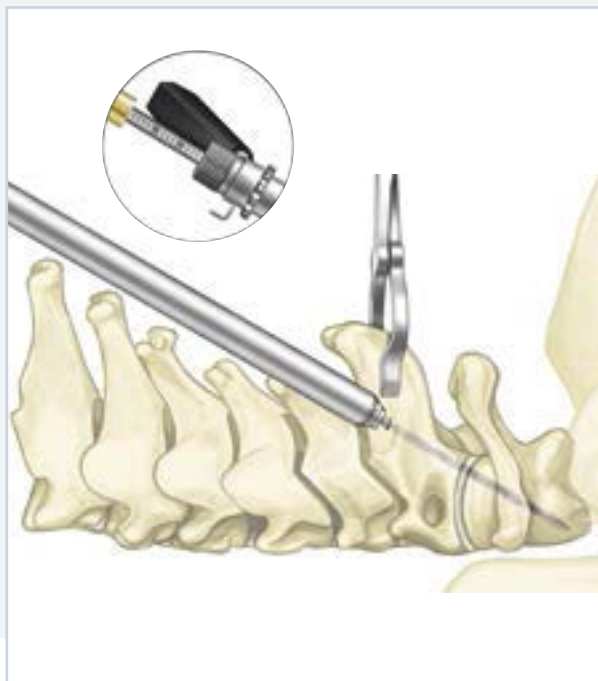

Fig. 30: Drilling

Navigated Operation C1-C2 – Drilling

- To drill the hole, insert the inner drill sleeve (FJ985R/FW661R) and the corresponding drill bit (FW088SU/FW662SU) into the already placed navigated guide sleeve (FW660). The inner drill sleeve engages on the inner sleeve and can still be rotated.
- Drill to the intended depth under control with the Brainlab navigation system. The drill depth can be read on the scale on inner drill sleeve.

For Ø 3.5 mm screws:

- Drill Ø 2.4 mm (FW662SU)
- Navigated guide sleeve (FW660R)
- Inner drill sleeve Ø 3.5 mm screws (FW661R)

For Ø 4.0 mm screws:

- Drill Ø 2.9 mm (FW088SU)
- Navigated guide sleeve (FW660R)
- Inner drill sleeve Ø 4.0 mm screws (FJ985R)

S4[®] Cervical Navigation

Surgical Technique



Fig. 31: Tapping

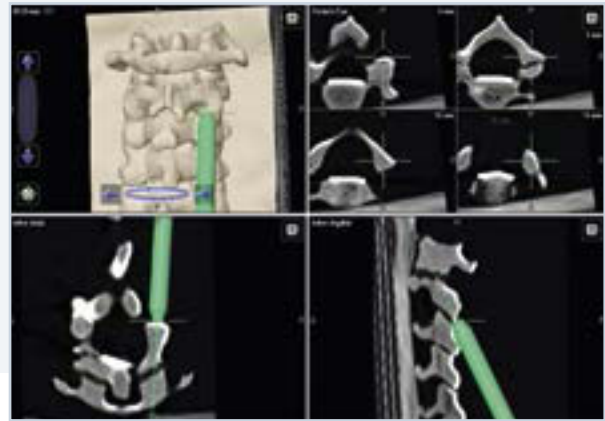

Navigated Operation C1-C2 – Tapping

- S4[®] Cervical screws are equipped with a self-tapping tip. To ensure optimal bone purchase for easier starting of the screw tapping is recommended for the first 3 mm into the C2 as an optional step. Also optionally tapping can be performed through C2 into the C1.
- Prior to tapping remove the inner drill sleeve (FJ985R/ FW661R) from the navigated guide sleeve (FW660).
- To tap the pre-drilled hole use the corresponding tap (FW663R/ FW089R) through the navigated guide sleeve (FW660). The tap has a scale to reconfirm the depth.
- Before placing the screw the reduction inner sleeve of the sleeve guide needs to be removed by turning the wheel counterclockwise. With the navigated guide sleeve (FW660R) remaining in-situ the screw can be inserted through the sleeve using the non-navigated self-retaining screwdriver (FW069R).

For Ø 3.5 mm screws:

- Tap for Ø 3.5 mm screws (FW663R)
- Navigated guide sleeve (FW660R)

For Ø 4.0 mm screws:

- Tap for Ø 4.0 mm screws (FW089R)
- Navigated guide sleeve (FW660R)

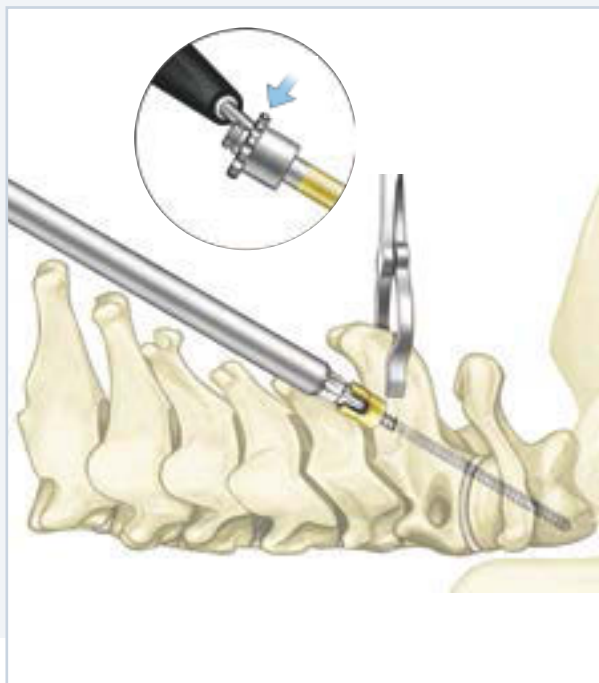

Fig. 32: Screw Insertion

Navigated Operation C1-C2 – Screw Insertion

- Before placing the screw the reduction inner sleeve of the sleeve guide needs to be removed by turning the wheel counterclockwise. With the navigated guide sleeve (FW660R) remaining in-situ the screw can be inserted through the sleeve using the non-navigated self-retaining screwdriver (FW069R).

S4[®] Cervical Navigation

Instrumentation Possibilities – Summary



Navigated Polyaxial Screw Fixation C1-Th3

for Ø 3.5 mm screws



FW664R



FW688R



FW666SU

for Ø 4.0 mm screws



FW665R



FW689R



FW667SU

for Ø 3.5 mm and Ø 4.0 mm screws



FW655R



FW656R

S4[®] Cervical Navigation

Instrumentation Possibilities – Summary

Navigated C1-C2 Transarticular Screw Fixation

for Ø 3.5 mm and Ø 4.0 mm screws



FW660R



FJ983R



FJ984R

for Ø 3.5 mm screws



FW661R



FW662SU



FW663R

for Ø 4.0 mm screws



FJ985R



FW088SU



FW089R

for Ø 3.5 mm and Ø 4.0 mm screws



FW069R

Navigated C1 Screw Fixation

for Ø 4.0 mm Smooth-Shank Screws



FW658R

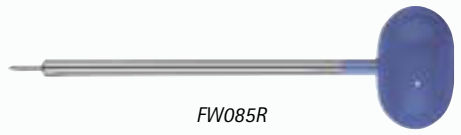

FW085R



FW086SU



FW087R













FW128R











FW070R

S4[®] Cervical Navigation

Instrument Overview and Set

Instruments	Article No.	Description	Recommended
	FW664R	Navigated Drill Guide for Ø 3.5 mm Screws	1
	FW688R	Cortical Punch for Navigated Drill Guide Ø 3.5 mm	1
	FW666SU	Drill Ø 2.4 mm for Navigated Drill Guide Ø 3.5 mm	2
	FW665R	Navigated Drill Guide for Ø 4.0 mm Screws	1
	FW689R	Cortical Punch for Navigated Drill Guide Ø 4.0 mm	1
	FW667SU	Drill Ø 2.9 mm for Navigated Drill Guide Ø 4.0 mm	2
	FW655R	Navigated Tap Ø 3.5 mm	1
	FW656R	Navigated Screwdriver for Polyaxial Screws	1
	Brainlab 55830-20A	Instrument Star Unit (Pre-Calibrated)	1
	Brainlab 55830-25A	Instrument Star Unit ML (Calibration with ICM4)	1

Instruments	Article No.	Description	Recommended
	FW658R	Navigated Guide Sleeve Ø 4.0 mm for Smooth-Shank Screws	1
	FW660R	Navigated Guide Sleeve for Ø 3.5 mm and 4.0 mm Screws	1
	FJ985R	Inner Drill Sleeve for Ø 4.0 mm Screws	1
	FW661R	Inner Drill Sleeve for Ø 3.5 mm Screws	1
	FW662SU	Drill Ø 2.4 mm for Ø 3.5 mm Screws	2
	FW663R	Tap for Ø 3.5 mm	1
	FW652R	Aesculap Star Unit Navigation Attachment	1
	FW657R	Reduction Sleeve Ø 13 mm for Calibration	1

Instrument Tray	Article No.	Description	Recommended
	JK489	Full-Size Lid with Retention Plate Silver	1
	JK442	Bottom for 1 / 1 Container Height: 135 mm	1
	FW651R	S ⁴ C Tray for Navigated Instruments	1
	JH217R	1 / 1 Size Wide Perf. Basket Lid 489 x 257 mm	1
	TF033	Packing Stencil for FW651R (FW650)	1
	TF034	Graphic Template for FW651R (FW650)	1

